

# POWERTILT®

Next Generation

Tilt Any Bucket  
or Attachment  
up to 180 Degrees



# THE NEXT GENERATION OF TILTING

## INTEGRAL ROTARY UNION FOR COUPLER

- Eliminates hoses and hose guards
- Simplified hose routings

## REDUCED WEIGHT

- Better stability
- Decreased fuel costs

## IMPROVED HOLDING FORCE

- Increased productivity

## HARDENED SEAL AND BEARING SURFACES

- Reduced cost of ownership
- Longer life

## INTEGRATED CROSS-PORT RELIEF VALVE

- Overload protection

## VERSATILE COUPLER CONFIGURATIONS

- Available with common couplers
- Adaptable to a variety of buckets and attachments

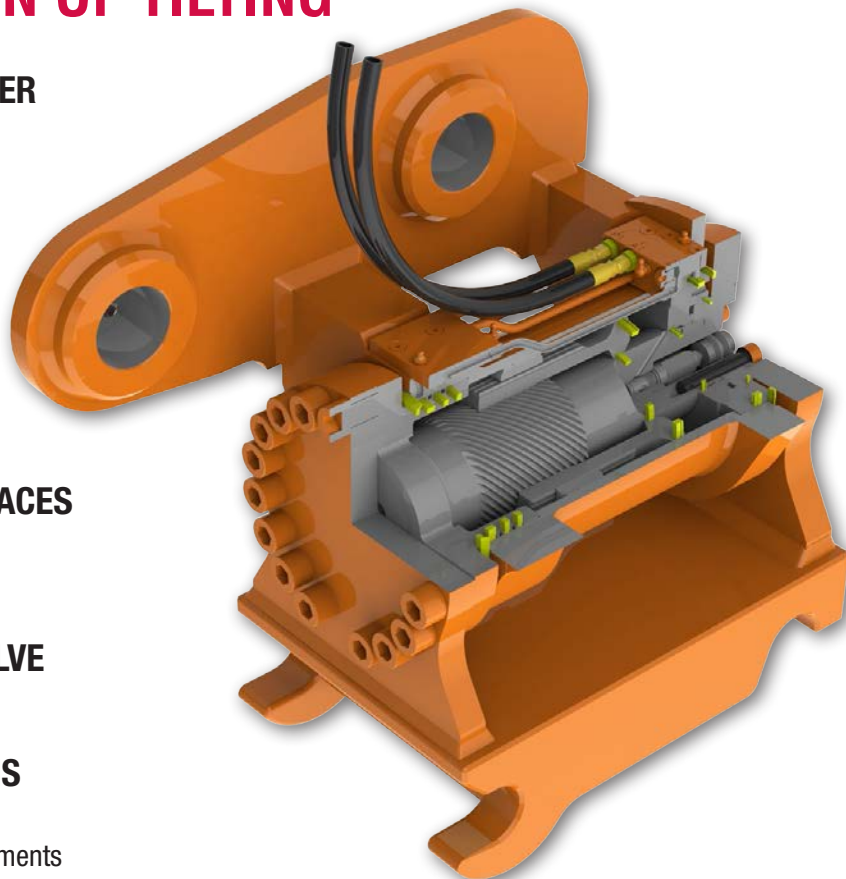





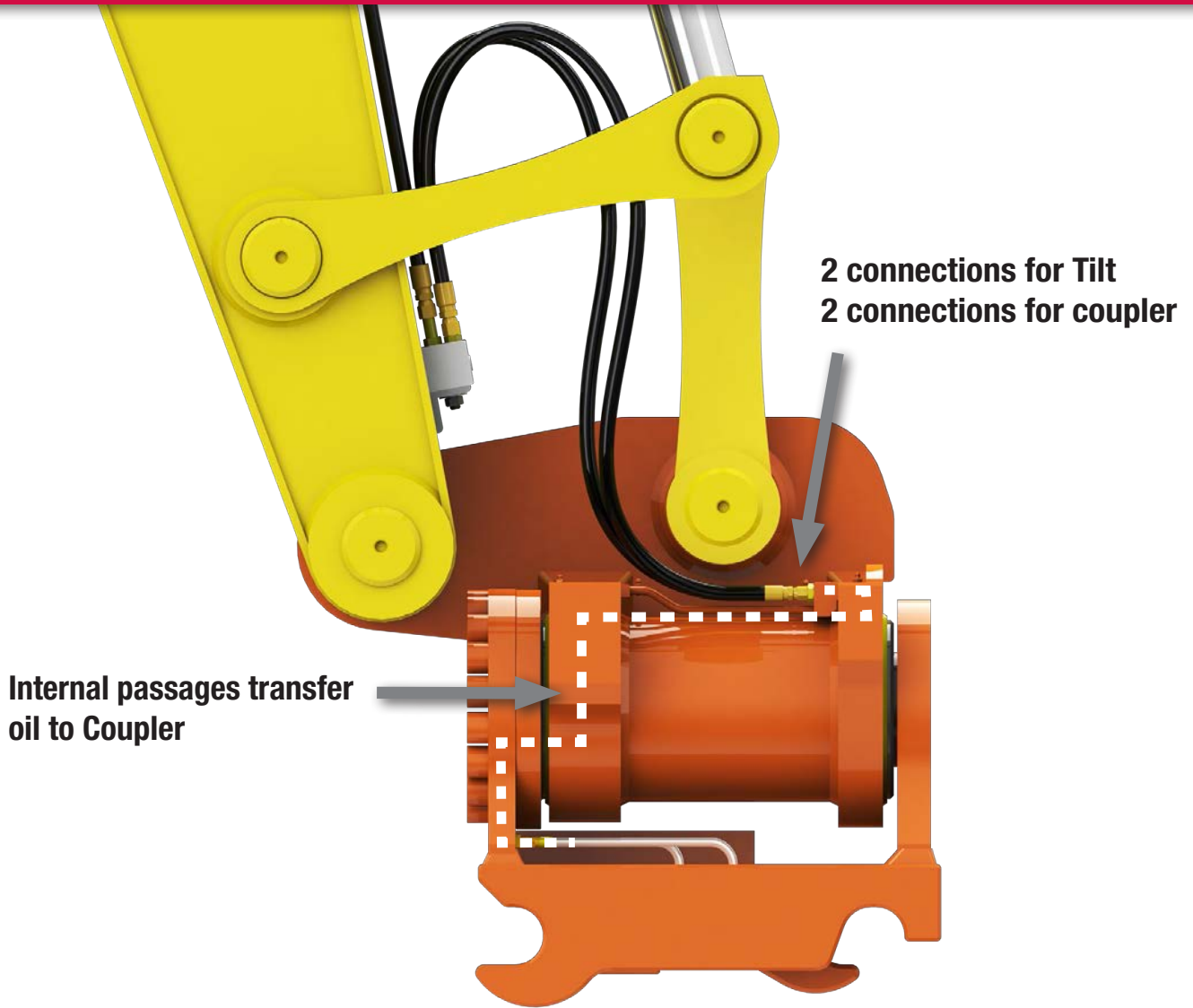

POWERTILT SPECIFICATIONS		4.5 **	030	050	070	100	180	240	300	465
<b>Maximum Machine Weight</b>	kg	1 800	3 000	5 000	7 000	10 000	18 000	24 000	32 000	50 000
	lbs	4 000	6 600	11 000	15 500	22 000	40 000	53 000	70 000	110 000
<b>Approximate PowerTilt Weight*</b>	kg	34	38	56	96	137	253	357	450	574
	lbs	75	84	123	211	302	557	785	990	1 260
<b>Total Tilt</b>		180°	180°	180°	180°	180°	120°	120°	120°	120°
<b>Driving Torque</b>										
Nm @ 207 bar		930	1 630	2 600	4 375	6 650	13 300	17 875	24 900	44 300***
in-lbs @ 3000 psi		8 200	14 400	22 900	38 700	58 800	117 600	158 200	220 400	392 000
<b>Holding Torque</b>										
Nm @ 225 bar		2 470	6 425	9 350	14 850	20 450	40 725	53 100	70 330	111 800***
in-lbs @3250 psi		21 900	56 900	82 800	131 400	180 900	360 400	470 000	622 400	989 500
<b>Required Oil Flow</b>	l/min	3-7	6-19	9-28	13-38	19-58	26-78	35-105	47-142	54-162
	GPM	1-2	1.7-5	2.5-7.5	3.3-10	5-15	7-21	9-28	13-38	16-48
<b>Circuit Pressure Max</b>	bar	207	207	207	207	207	207	207	207	310
	psi	3 000	3 000	3 000	3 000	3 000	3 000	3 000	3 000	4 500
<b>Oil Passages for Quick Coupler</b>		0	2	2	2	2	2	2	2	2

\* Weight with side plates, bosses and feet, no coupler \*\* Includes integrated pilot operated check valve as standard

\*\*\* PT-465 Nm @ 310 bar (Driving Torque) and PT-465 Nm @ 325 bar (Holding Torque)

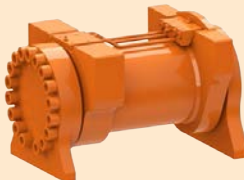

## POWERTILT CONFIGURATIONS

PT Series	PTS Series	PTA/PTS Blank Series	Custom Designs
	 	 	 





Finish Grading



Underground Utilities



Ditch Cleaning



Metering Fill Material



Demolition



Brushcutting



Trench Safety



Ripping Tooth



Landscaping

